

Installation Instructions

100DR

Typical Installation

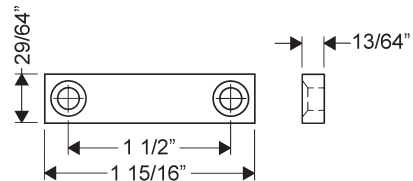
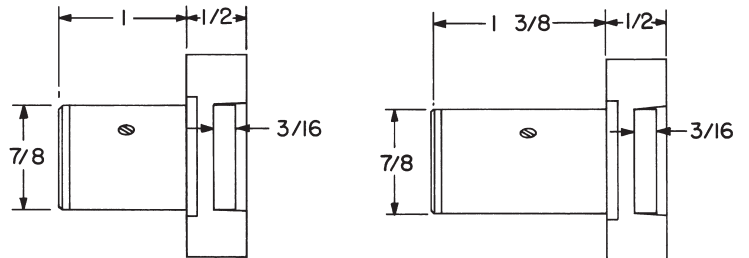
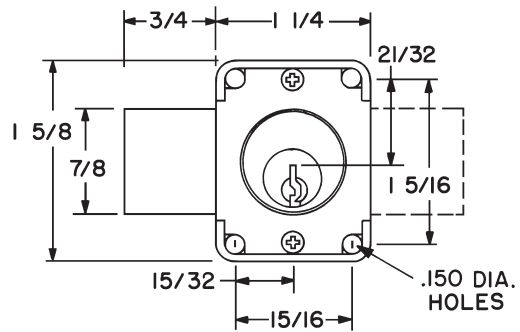
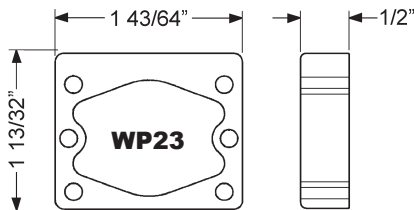
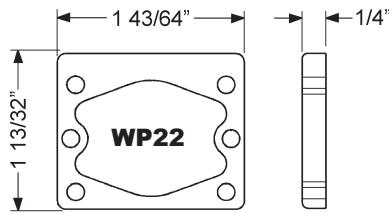
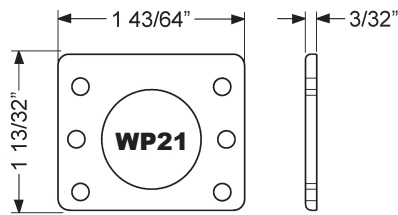
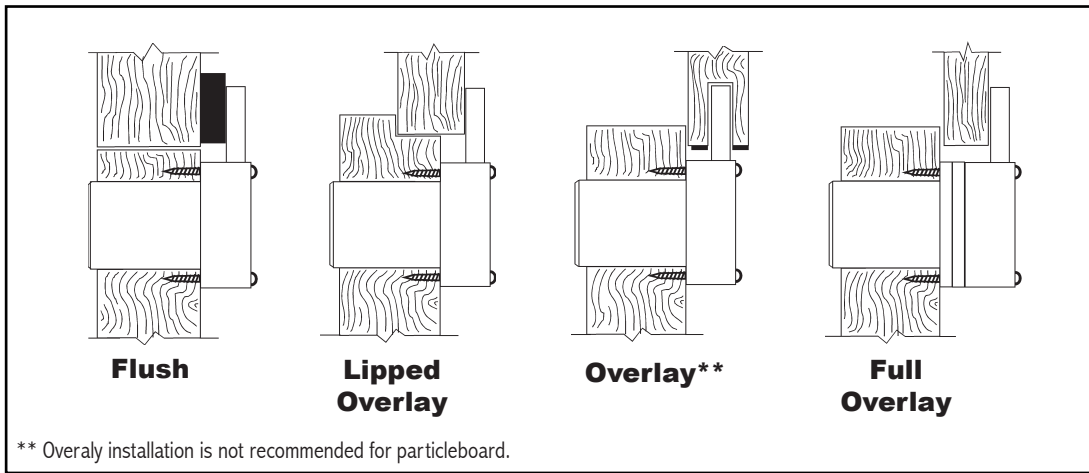

56-1 - bar strike

Note: Use of spacers and strikes depends on application and material thickness.

Title Installation instructions for 100DR series cabinet door lock				
Series 100DR	Barrel Length 7/8" or 1-3/8"	Bolt type Deadbolt	Mounting Surface	Revision Date 11/2013

